



Nature • Nature-branded • Academic journals

PRINT SPECIFICATIONS

Requirements for display and classified advertising, inserts and outserts

ADVANCING
DISCOVERY

Contents

This document contains the specifications for display advertising, classified advertising, and inserts/outserts for *Nature*, Nature-branded journals and Academic journals, which are printed across the world in a variety of formats and by several print houses. As such, the advertising available for individual titles varies along with the advert dimensions and who to contact or send samples to. Please follow the instructions (right) to find the details you need.

General information

- 3 Technical specifications
- 3 Proofs
- 3 Production contacts
- 3 Further information

Display advertising

- 4 Table of Display advertising available by journal
- 4 Display advert dimensions

Classified advertising

- 5 Table of Classified advertising available by journal
- 6 Classified advert dimensions

Inserts and outserts

- 7 Table of inserts and outserts available by journal
- 7 Insert samples
- 8 Insert/outsert specifications
- 11 Delivery instructions

Index of journals

- 12 Index of journals covered by this document

USING THIS GUIDE

- In the appropriate section, first find the journal of interest in the Table, then read across to discover the journal's page size, what is available for that title, and the Production contact.
- If you need to contact Production, the details are listed on page 3.
- The precise dimensions and other specifications for the various adverts are presented after the tables.
- Finally, take note of the technical specifications and other details on page 3.



Can't find the journal in the Table of interest?

Use the Index of Journals on page 12 to discover the journal group and subgroup, then find the corresponding row in the relevant Table.

Although we make every effort to ensure that the specifications in this document are accurate, they can be subject to change. Therefore, please check the specifications with us before sending any material for design or print.

General information

Technical specifications

Artwork should be supplied in PDF format. To ensure good reproduction of your artwork please supply a PDF to PDF/X-1a standard. If this is not possible, supply a standard CMYK, high resolution PDF (at least 300dpi), with all fonts and images embedded. Ensure that bleed is included and clearly shown with bleed marks.

- PDFs should not use any passwords or security options
- Artwork should be pre-flattened so there are no transparent objects in the supplied file
- Full page advertisements must have a bleed of 3.175 mm (0.125")
- Should not exceed ink density of 300%

Colour

- All files must use a CMYK or greyscale colour space
- No spot colours should be used
- No colour management, ICC profiles or Lab colour should be used

Images

- Images should be no less than 300dpi
- Images must be CMYK or greyscale

Proofs

For best colour reproduction you must supply an accurate colour proof. Send via conventional mail to your production contact. The proof must have been created from the same digital files as those supplied to us. For monochrome advertisements, a laser print is sufficient.

Please send proofs to the Production contact for the journal of interest, as indicated in the Tables. See right for mailing address

Further information

For further information, help and advice on any aspect of digital production please contact either Jason Rayment or Michael Broomes, depending on the journal:

For journals with the Production contact listed as AR, RT or SF (see Tables), please contact

Jason Rayment

Tel: +44 (0)20 7843 4807
jason.rayment@springernature.com

For journals with the Production contact listed as BD, DC, DR, MKM or RS (see Tables), please contact

Michael Broomes

Tel: +1 212 726 9302
m.broomes@us.nature.com

PRODUCTION CONTACTS

Our production staff work on designated titles, please see the Tables to identify your Production contact.

At the London office:

Springer Nature Limited,
The Campus, 4 Crinan Street,
London, N1 9XW, UK.

AR = Ann Rees

Tel: +44 (0)20 7843 4726
ann.rees@springernature.com

RT = Richard Thomas

Tel: +44 (0)20 7843 4824
richard.thomas@springernature.com

SF = Stewart Fraser

Tel: +44 (0)20 7843 4809
s.fraser@springernature.com

At the New York office:

Springer Nature America, Inc.,
1 New York Plaza, Suite 4600,
New York, NY 10004-1562, USA.

BD = Brittany DeSalvo

Tel: +1 212 726 9208
brittany.desalvo@us.nature.com

DC = Dan Chen

Tel: +1 212 726 9327
dan.chen@us.nature.com

DR = Diane Rios

Tel: +1 212 726 9354
d.rios@us.nature.com

MKM = Madelyn Keyes-Milch

Tel: +1 212 451 8595
mkeyes@sciam.com

RS = Rebecca Suzuki

Tel: +1 212 726 9627
rebecca.suzuki@us.nature.com

Display advertising

Journal title	Display advertising available							Production contact
	Full page trim	Double page spread	1/2 Vertical	1/2 Horizontal	1/4 Vertical	1/3 Vertical	Island	
<i>Nature</i>	●	●	●	●	●	●		RT
Nature Research Journals								
<i>BioPharma Dealmakers</i> ‡ (also bound in with NBT and NRDD)	●	●	●	●	●			RT
<i>Nat. Cell Biol.</i> • <i>Nat. Chem.</i> • <i>Nat. Climate Chang.</i> • <i>Nat. Geosci.</i> • <i>Nat. Mater.</i> • <i>Nat. Nanotechnol.</i> • <i>Nat. Photonics</i> • <i>Nat. Phys.</i>	●	●	●	●	●	●		AR
<i>Lab Anim.</i> ‡ • <i>Nat. Biotechnol.</i> (NBT) • <i>Nat. Chem. Biol.</i> • <i>Nat. Genet.</i> • <i>Nat. Immunol.</i> • <i>Nat. Med.</i> • <i>Nat. Neurosci.</i> • <i>Nat. Struct. Mol. Biol.</i>	●	●	●	●	●	●	NBT only	DC
<i>Nat. Methods</i>	●	●	●	●	●	●	●	RS
Nature Reviews (Life Science)								
<i>Nat. Rev. Cancer</i> • <i>Nat. Rev. Drug Discov.</i> (NRDD) • <i>Nat. Rev. Genet.</i> • <i>Nat. Rev. Immunol.</i> • <i>Nat. Rev. Microbiol.</i> • <i>Nat. Rev. Mol. Cell Biol.</i> • <i>Nat. Rev. Neurosci.</i>	●	●	●	●	●	●		RS
Nature Reviews (Clinical)								
<i>Nat. Rev. Cardiol.</i> • <i>Nat. Rev. Clin. Oncol.</i> • <i>Nat. Rev. Endocrinol.</i> • <i>Nat. Rev. Gastroenterol. Hepatol.</i> • <i>Nat. Rev. Nephrol.</i> • <i>Nat. Rev. Neurol.</i> • <i>Nat. Rev. Rheumatol.</i> • <i>Nat. Rev. Urol.</i>	●	●	●	●				RS
Academic Journals								
<i>Bone Marrow Transplant.</i> • <i>Br. J. Cancer</i> • <i>Cell Death Differ.</i> • <i>Eur. J. Clin. Nutr.</i> • <i>Eur. J. Hum. Genet.</i> • <i>Eye</i> • <i>Gene Ther.</i> • <i>Heredity</i> • <i>Int. J. Obes.</i> • <i>ISME J</i> • <i>J. Hum. Hypertens.</i> • <i>Leukemia</i> • <i>Oncogene</i> • <i>Spinal Cord.</i>	●	●	●	●				AR
<i>Cancer Gene Ther.</i> • <i>Genet. Med.</i> • <i>Int. J. Impot. Res.</i> • <i>J. Expo. Sci. Environ. Epidemiol.</i> • <i>J. Perinatol.</i> • <i>Lab Invest.</i> • <i>Mod. Pathol.</i> • <i>Mol. Psychiatry</i> • <i>Mucosal Immunol.</i> • <i>Neuropsychopharmacology</i> • <i>Pediatr. Res.</i> • <i>Prostate Cancer Prostatic Dis.</i> • <i>Pharmacogenomics J.</i>	●	●	●	●				DC

Production contacts: See page 3 for details.

‡ Indicates saddle-stitched binding; all other titles are perfect bound.

Display advert dimensions

All journals are printed in a portrait format at a trimmed page size of 210 mm × 279 mm (8.25" × 11"). Please check the Table to ensure that the advert size you require is available or contact your sales representative. See below for the advert trim dimensions.

Please supply with an extra 3.175 mm (0.125") of bleed for all adverts that run to the edge of the page. Also ensure that all text and logos are placed no closer than 10 mm (0.4") from the trim. See page 3 for technical specifications.

Full page trim

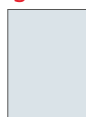

Trim size (width × height)
210 mm × 279 mm
(8.25" × 11")

Double page spread



Trim size (width × height)
420 mm × 279 mm
(16.5" × 11")

Half vertical

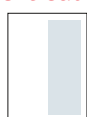

Advert size (width × height)
86 mm × 254 mm
(3.375" × 10")

Half horizontal

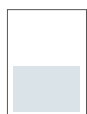

Advert size (width × height)
178 mm × 124 mm
(7" × 4.875")

Third vertical

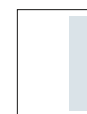

Advert size (width × height)
56 mm × 254 mm
(2.25" × 10")

Quarter vertical

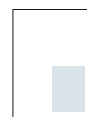

Advert size (width × height)
86 mm × 124 mm
(3.375" × 4.875")

Island

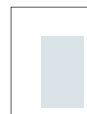

Advert size (width × height)
112 mm × 188 mm
(4.5" × 7.375")

Classified advertising

Journal title	Classified advertising available													Production contact	
	Full page trim	Full page type area	Double page spread	1/2 Vertical	1/2 Horizontal	1/4 Vertical	1/3 Vertical	2/3 Vertical	1/6 Vertical	1/3 Square	1 column	2 column	3 column		4 column
<i>Nature</i>	●	●	●	●	●	●	●	●	●	●	●	●	●	●	RT
Nature Research Journals															
<i>Nat. Cell Biol.</i> • <i>Nat. Chem.</i> • <i>Nat. Climate Chang.</i> • <i>Nat. Geosci.</i> • <i>Nat. Mater.</i> • <i>Nat. Nanotechnol.</i> • <i>Nat. Photonics</i> • <i>Nat. Phys.</i>	●	●	●	●	●	●	●	●	●	●	●	●	●	●	AR
<i>Nat. Biotechnol.</i> (NBT) • <i>Nat. Chem. Biol.</i> • <i>Nat. Genet.</i> • <i>Nat. Immunol.</i> • <i>Nat. Med.</i> • <i>Nat. Neurosci.</i> • <i>Nat. Struct. Mol. Biol.</i>	●	●	●	●	●	●	●	●	●	●	●	●	●	●	DC
<i>Nat. Methods</i>	●	●	●	●	●	●	●	●	●	●	●	●	●	●	RS
Nature Reviews (Life Science)															
<i>Nat. Rev. Cancer</i> • <i>Nat. Rev. Drug Discov.</i> (NRDD) • <i>Nat. Rev. Genet.</i> • <i>Nat. Rev. Immunol.</i> • <i>Nat. Rev. Microbiol.</i> • <i>Nat. Rev. Mol. Cell Biol.</i> • <i>Nat. Rev. Neurosci.</i>	●	●	●	●	●	●	●	●	●	●	●	●	●	●	RS
Nature Reviews (Clinical)															
<i>Nat. Rev. Cardiol.</i> • <i>Nat. Rev. Clin. Oncol.</i> • <i>Nat. Rev. Endocrinol.</i> • <i>Nat. Rev. Gastroenterol. Hepatol.</i> • <i>Nat. Rev. Nephrol.</i> • <i>Nat. Rev. Neurol.</i> • <i>Nat. Rev. Rheumatol.</i> • <i>Nat. Rev. Urol.</i>	●		●	●	●										RS
Academic Journals ‡															
<i>Bone Marrow Transplant.</i> • <i>Br. J. Cancer</i> • <i>Cell Death Differ.</i> • <i>Eur. J. Clin. Nutr.</i> • <i>Eur. J. Hum. Genet.</i> • <i>Eye</i> • <i>Gene Ther.</i> • <i>Heredity</i> • <i>Int. J. Obes.</i> • <i>ISME J</i> • <i>J. Hum. Hypertens.</i> • <i>Leukemia</i> • <i>Oncogene</i> • <i>Spinal Cord.</i>	●		●	●	●										AR
<i>Cancer Gene Ther.</i> • <i>Genet. Med.</i> • <i>Int. J. Impot. Res.</i> • <i>J. Expo. Sci. Environ. Epidemiol.</i> • <i>J. Perinatol.</i> • <i>Lab Invest.</i> * • <i>Mod. Pathol.</i> * • <i>Mol. Psychiatry</i> • <i>Mucosal Immunol.</i> • <i>Neuropsychopharmacology</i> • <i>Pediatr. Res.</i> • <i>Prostate Cancer Prostatic Dis.</i> • <i>Pharmacogenomics J.</i>	●		●	●	●	*	*	*	*	*					DC

Production contacts: See page 3 for details.

**Lab Investigations* and *Modern Pathology* can also have these fractional sizes — they can be booked in via our US sales team.

‡ Classified advertising in the Academic journals follow the Display dimensions, see page 4.

Classified advert dimensions

All journals are printed in a portrait format at a trimmed page size of 210 mm × 279 mm (8.25" × 11"). Please check the Table to ensure that the advert size you require is available or contact your sales representative. See below for the advert trim sizes.

Please supply with an extra 3.175 mm (0.125") of bleed for all adverts that run to the edge of the page. Also ensure that all text and logos are placed no closer than 10 mm (0.4") from the trim. See page 3 for technical specifications.

Full page trim

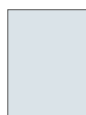

Trim size (width × height)
210 mm × 279 mm
(8.25" × 11")

Full page type area



Advert size (width × height)
186 mm × 260 mm
(7.375" × 10.25")

Double page spread



Trim size (width × height)
420 mm × 279 mm
(16.5" × 11")

Half vertical

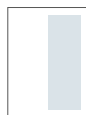

Advert size (width × height)
92 mm × 260 mm
(3.625" × 10.25")

Half horizontal



Advert size (width × height)
186 mm × 130 mm
(7.375" × 5.125")

Quarter vertical

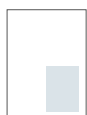

Advert size (width × height)
92 mm × 130 mm
(3.625" × 5.125")

Two thirds vertical

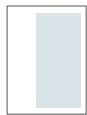

Advert size (width × height)
124 mm × 260 mm
(4.875" × 10.25")

Third vertical

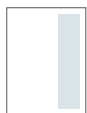

Advert size (width × height)
57 mm × 260 mm
(2.25" × 10.25")

Third square

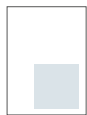

Advert size (width × height)
124 mm × 124 mm
(4.875" × 4.875")

Sixth vertical

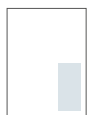

Advert size (width × height)
57 mm × 124 mm
(2.25" × 4.875")

Column-width advertisements

The advert height can be up to 26 cm in increments of 1 cm. The overall size is described by height and number of columns; for example, 16 cm high and 2 columns wide is described as 16 × 2.

1 Column



Advert size (width × height)
44 mm × 10–260 mm

2 Column



Advert size (width × height)
92 mm × 10–260 mm

3 Column



Advert size (width × height)
140 mm × 10–260 mm

4 column



Advert size (width × height)
186 mm × 10–260 mm

Inserts and outserts

Journal title	Inserts/outserts available													
	Internal use	Tip-on	Loose insert	Loose outsert	Poster	Two/four page bound insert	Four panel rollfold	Butterfly gatefold	Cover rollfold	Barn door cover	Cover flap	Belly band	Blow-in card	Production contact
<i>Nature</i>	Gb	●	●	●	●	●	●	●				●	●	SF
Nature Research Journals														
<i>Lab Anim.</i> ‡	LSC	●	●	●	●	●	●	●	●			●	●	BD
<i>Nat. Biotechnol.</i> (NBT) • <i>Nat. Immunol.</i> • <i>Nat. Struct. Mol. Biol.</i>	Sh	●	●	●	●							●		MKM
<i>Nat. Cell Biol.</i> • <i>Nat. Chem.</i> • <i>Nat. Climate Chang.</i> • <i>Nat. Geosci.</i> • <i>Nat. Mater.</i> • <i>Nat. Nanotechnol.</i> • <i>Nat. Photonics</i> • <i>Nat. Phys.</i>	Bx	●	●	●	●	●	●	●	●	●		●		SF
<i>Nat. Chem. Biol.</i>	Bx	●	●	●	●	●	●	●	●	●		●		DR
<i>Nat. Genet.</i> • <i>Nat. Med.</i> * • <i>Nat. Neurosci.</i>	Sh	●	●	●	●	*	*	*	*	*		●		DR
<i>Nat. Methods</i>	LSC	●	●	●	●	●	●	●	●			●	●	DR
Nature Reviews (Life Science)														
<i>Nat. Rev. Drug Discov.</i> (NRDD)	Bx	●	●	●	●	●	●	●	●	●		●		SF
<i>Nat. Rev. Cancer</i> • <i>Nat. Rev. Genet.</i> • <i>Nat. Rev. Immunol.</i> • <i>Nat. Rev. Microbiol.</i> • <i>Nat. Rev. Mol. Cell Biol.</i> • <i>Nat. Rev. Neurosci.</i>	PF	●	●	●	●									SF
Nature Reviews (Clinical)														
<i>Nat. Rev. Cardiol.</i> • <i>Nat. Rev. Clin. Oncol.</i> • <i>Nat. Rev. Endocrinol.</i> • <i>Nat. Rev. Gastroenterol. Hepatol.</i> • <i>Nat. Rev. Nephrol.</i> • <i>Nat. Rev. Neurol.</i> • <i>Nat. Rev. Rheumatol.</i> • <i>Nat. Rev. Urol.</i>	PF	●	●	●	●									SF
Academic Journals														
<i>Bone Marrow Transplant.</i> • <i>Br. J. Cancer</i> • <i>Cell Death Differ.</i> • <i>Eur. J. Clin. Nutr.</i> • <i>Eur. J. Hum. Genet.</i> • <i>Gene Ther.</i> • <i>Heredity</i> • <i>Int. J. Obes.</i> • <i>ISME J.</i> • <i>J. Hum. Hypertens.</i> • <i>Leukemia</i> • <i>Oncogene</i> • <i>Spinal Cord</i>	PF		●	●	●									AR
<i>Eye</i>	Bx	●	●	●	●	●	●	●	●	●		●		AR
<i>Cancer Gene Ther.</i> • <i>Genet. Med.</i> * • <i>Int. J. Impot. Res.</i> • <i>J. Expo. Sci. Environ. Epidemiol.</i> • <i>J. Perinatol.</i> * • <i>Lab Invest.</i> • <i>Mod. Pathol.</i> * • <i>Mol. Psychiatry</i> • <i>Mucosal Immunol.</i> * • <i>Neuropsychopharmacology</i> • <i>Pediatr. Res.</i> * • <i>Prostate Cancer Prostatic Dis.</i> • <i>Pharmacogenomics J.</i>	Sh	●	●	●	●	*	*	*	*	*		●		DC

Production contacts: See page 3 for details.

‡Indicates saddle-stitched binding; all other titles are perfect bound.

*Indicates inserts available for specific journals, check with your sales rep.

Insert samples

A sample of the insert needs to be approved by the Production department prior to insertion with the journal. Ideally this should be the actual piece, but if not available, a mock-up trimmed to the exact dimensions, using the same paper and folded or perforated as the final insert would be, should be provided. This needs to be with us at least two weeks prior to the issue date. A digital copy can also be sent in advance to check for content.

Please send 5 samples to the Production contact for the journal (see Table), clearly identifying the front and back of the insert, or the page numbers where appropriate.

See below for insert specifications and also page 3 for other technical specifications. Once approved, inserts will need to be delivered to the relevant printing house; follow the delivery instructions from your Production contact.

If you have any queries regarding inserts please contact the production department.

Insert/outsert specifications

All journals are printed in a portrait format at a trimmed page size of 210 mm × 279 mm (8.25" × 11"). Please check the Table to ensure that the type of insert/outsert you require is available or contact Production. Listed on the following pages are the permitted dimensions and paper weights for the specific insert types.

It may be possible to accommodate types of inserts other than those shown in the Table above; please contact your sales representative to discuss any special requirements.

Although we make every effort to ensure that these specifications are accurate, they can be subject to change. Therefore, please check the specifications with us before sending any material for design or print.

Tip-on

- Supply to the trimmed size.
- Must be square or portrait.
- Front cover tip-ons will be positioned in the bottom left-hand corner.
- A tip-on can have a specified position on the page; however, there is a movement tolerance of up to 10 mm (0.4")

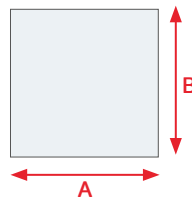

Width A	Height B	Paper weight
120–205 mm (4.75–8.125")	120–205 mm (4.75–8.125")	115–170 gsm (78–115 lbs)

Loose insert

- Must be supplied to the trimmed size.
- It is not possible to insert a concertina (z-fold) folded insert.
- Inserts must have a closed spine.
- All loose inserts of four pages or more are fed into the publication spine first.
- Should be no more than 8 pages.
- Maximum overall weight for the insert is 90 grams (3 oz). For heavier items please contact your sales representative as this will incur extra distribution costs.
- Postal regulations in the USA greatly increase the cost of running loose inserts.

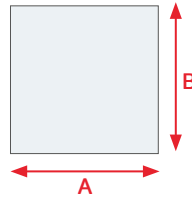

Width A	Height B	Paper weight
102–190 mm (4–7.5")	150–259 mm (6–10.125")	115–170 gsm (78–115 lbs)

Loose outsert

- Must be supplied to the trimmed size.
- It is not possible to insert a concertina (z-fold) folded insert.
- Outserts must have a closed spine.
- Must be no more than 32 pages.
- Maximum overall weight for the outsert is 90 grams (3 oz). For heavier items please contact your sales representative as this will incur extra distribution costs. We recommend for a single sheet, 90–150 gsm; for 4–6 pages, 70–130 gsm; and for 8–32 pages, 48–80 gsm.

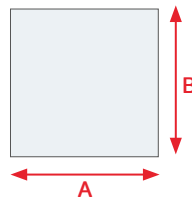

Width A	Height B	Paper weight*
102–210 mm (4–8.25")	150–279 mm (6–11")	115–170 gsm (78–115 lbs)

*Use a paper weight to keep the overall weight of the outsert ≤ 90 grams.

Poster

- Posters are outserted.
- Must be supplied folded with a closed edge.
- Recommended paper weight is 130 gsm (90 lbs)

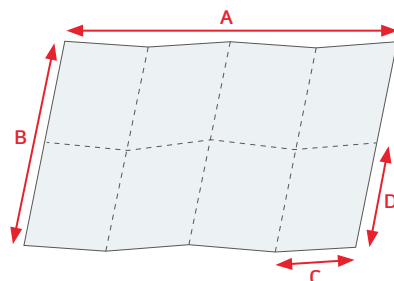

Poster	Size A × B	Folded C × D
Regular (folds to 8 panels)	750 × 520 mm (29.5 × 20.5")	187.5 × 260 mm (7.375 × 10.25")
Large (folds to 16 panels)	876 × 558 mm (34.5 × 22")	219 × 139.5 mm (8.675 × 5.5")

Two/four-page bound insert

- Must be supplied at the untrimmed size.
- All text should be at least 10 mm (0.4") from the edge of the final trim size.
- The height of the insert must exceed the width.
- Four-page inserts must be pre-folded on the spine edge. Include a 3 mm (0.125") spine trim on each page in the centrefold (6 mm total) — it will be trimmed on binding.

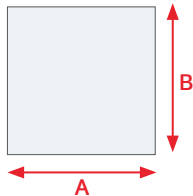

Width A	Height B	Head trim	Spine trim	Foot trim [†]	Fore-edge trim [‡]	Paper weight
120–210 mm (4.75–8.25")	150–279 mm (6–11")	10 mm * [#] (0.375")	3 mm (0.125")	3 mm # (0.125")	3 mm # (0.125")	115–170 gsm (78–115 lbs)

[†] A foot trim is required only if the insert is at maximum height.

[‡] A fore-edge trim is required only if the insert is at maximum width.

* For *Nature* 'Americas edition' and Springer Research journals, the Head trim should be 3 mm (0.125").

For journals printed by Buxton Press, the Head trim and Foot trim = 4.5 mm, and Fore-edge trim = 5 mm.

Four-panel rollfold

- Must be supplied pre-folded to the untrimmed size.
- It is not possible to insert a concertina (z-fold) folded insert.
- The insert should be folded so that it opens out toward the right-hand side.
- Panels can be added by reducing the width by 5 mm for each additional panel.
- All text should be at least 10 mm (0.4") from the edge of the final trim size.

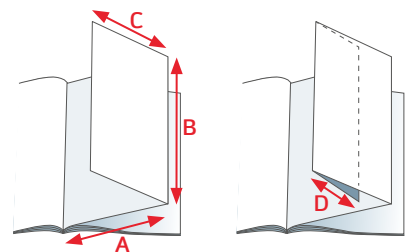

Width A	Height B	Width C	Width D [†]	Head trim	Spine trim	Foot trim	Paper weight
205 mm (8.125")	279 mm (11")	190 mm (7.5")	185 mm (7.25")	10 mm * [#] (0.375")	3 mm (0.125")	3 mm # (0.125")	115–170 gsm (78–115 lbs)

[†] For subsequent panels reduce width by 5 mm (0.25").

* For *Nature* 'Americas edition', the Head trim should be 3 mm (0.125").

For journals printed by Buxton Press, the Head trim and Foot trim should be 4.5 mm.

Butterfly gatefold

- Must be supplied pre-folded to the untrimmed size.
- It is not possible to insert a concertina (z-fold) folded insert.
- All text should be at least 10 mm (0.4") from the edge of the final trim size.

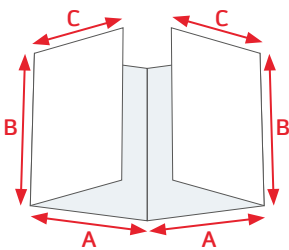

Width A	Height B	Width C	Head trim	Spine trim	Foot trim	Paper weight
205 mm (8.125")	279 mm (11")	190 mm (7.5")	10 mm * [#] (0.375")	3 mm (0.125")	3 mm # (0.125")	115–170 gsm (78–115 lbs)

* For *Nature* 'Americas edition', the Head trim should be 3 mm (0.125").

For journals printed by Buxton Press, the Head trim and Foot trim should be 4.5 mm.

Cover rollfold

- We print this with the journal cover. Supply as PDFs (single pages) adding 3.175 mm (0.125") bleed on each page and on all sides.

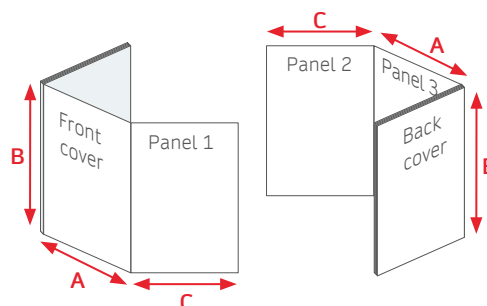

Width A	Height B	Width C
205 mm (8.125")	279 mm (11")	195 mm (7.625")

Barn door cover

- We print this with the journal cover. Supply as PDFs (single pages or spreads) adding 3.175 mm (0.125") bleed on each page and on all sides.

Width A	Height B	Width C
205 mm (8.125")	279 mm (11")	105 mm (4.125")

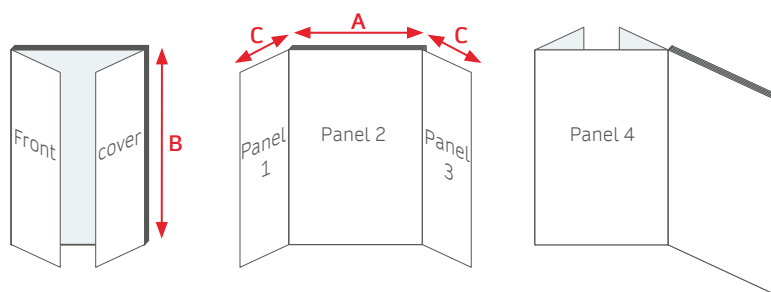

Belly band

- Belly bands are usually only possible on special distributions, such as conference copies. Contact your sales representative for details.
- Must be supplied pre-scored but unfolded
- The back panels will overlap (60 mm, 2.5"). Ensure that no text or important information is in this area.
- Contact us for spine width, which will depend on the journal's spine width,

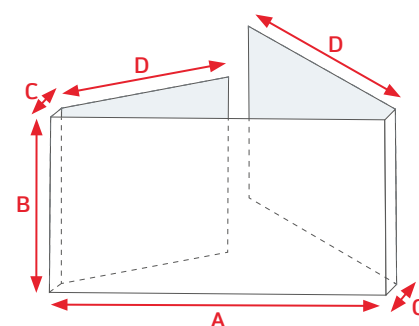

Width A	Height B	Spine width C	Width D
210 mm (8.25")	150 mm (6")	Variable	135 mm (5.375")

Blow-in card

- Must be supplied to the trimmed size.
- For *Nature*, the insert will be blown-in in the 'American edition' and loose inserted/outserted in the 'European edition' and 'Asia-Pacific edition'.

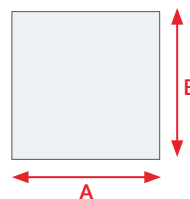

Width A	Height B	Paper weight
102–150 mm (4–6")	150 mm (6")	115–130 gsm (78–90 lbs)

Delivery instructions

Please note that failure to follow any of the following instructions could result in deliveries being refused.

All deliveries must be accompanied by a delivery note, attached to each box and on each face of a pallet. The delivery notes should state the following:

- Journal
- Issue date
- Advertiser/company
- Booking reference number
- Quantity in carton
- Total quantity delivered
- Carton number (e.g. 1 of 6)

If there is no information and if the driver of the delivery vehicle cannot obtain it, the inserts will not be accepted.

Attach the delivery note and a sample of the insert to each carton.

Up to 10 cartons can be accepted loose, any more than this should be supplied on a pallet. Pallets should be 800 × 1200 mm or 1000 × 1200 mm, sturdy, capable of stacking, allow four-way entry and well protected. Do not use metal straps.

- Pack inserts uniformly, facing upwards without turns.
- Do not mix inserts of a different type in a single delivery.
- A separate delivery note must be supplied for each insert.

The mailing address will be provided by your Production contact (see the Tables and page 3).

Quantity delivered

A minimum of 3% wastage allowance should be included in the quantity delivered.

Any overs will be destroyed and recycled after the issue is printed. If you require overs to be kept for future issues this may be subject to handling and storage costs.

Important

All freight and import charges must be pre-paid by the supplier. Springer Nature is not responsible for delivery, arrival or for any shipments held in customs for any reason while in transit.

Index of journals

Listed below are the journals covered by this specifications document. Find the journal of interest and note the Journal group and Subgroup to identify the correct rows to read from the Tables.

Journal title	Journal group	Subgroup
<i>BioPharma Dealmakers</i>	Nature Research Journals	Other
<i>Bone Marrow Transplantation</i>	Academic Journals	PF
<i>British Journal of Cancer</i>	Academic Journals	PF
<i>Cancer Gene Therapy</i>	Academic Journals	Sh
<i>Cell Death & Differentiation</i>	Academic Journals	PF
<i>European Journal of Clinical Nutrition</i>	Academic Journals	PF
<i>European Journal of Human Genetics</i>	Academic Journals	PF
<i>Eye</i>	Academic Journals	Bx
<i>Gene Therapy</i>	Academic Journals	PF
<i>Genetics in Medicine</i>	Academic Journals	Sh
<i>Heredity</i>	Academic Journals	PF
<i>International Journal of Impotence Research</i>	Academic Journals	Sh
<i>International Journal of Obesity</i>	Academic Journals	PF
<i>Journal of Exposure Science & Environmental Epidemiology</i>	Academic Journals	Sh
<i>Journal of Human Hypertension</i>	Academic Journals	PF
<i>Journal of Perinatology</i>	Academic Journals	Sh
<i>Lab Animal</i>	Nature Research Journals	LSC
<i>Laboratory Investigation</i>	Academic Journals	Sh
<i>Leukemia</i>	Academic Journals	PF
<i>Modern Pathology</i>	Academic Journals	Sh
<i>Molecular Psychiatry</i>	Academic Journals	Sh
<i>Mucosal Immunology</i>	Academic Journals	Sh
<i>Nature</i>	Nature	Gb
<i>Nature Biotechnology</i>	Nature Research Journals	Sh
<i>Nature Cell Biology</i>	Nature Research Journals	Bx
<i>Nature Chemical Biology</i>	Nature Research Journals	Bx
<i>Nature Chemistry</i>	Nature Research Journals	Bx
<i>Nature Climate Change</i>	Nature Research Journals	Bx
<i>Nature Genetics</i>	Nature Research Journals	Sh
<i>Nature Geoscience</i>	Nature Research Journals	Bx
<i>Nature Immunology</i>	Nature Research Journals	Sh
<i>Nature Materials</i>	Nature Research Journals	Bx
<i>Nature Medicine</i>	Nature Research Journals	Sh
<i>Nature Methods</i>	Nature Research Journals	LSC
<i>Nature Nanotechnology</i>	Nature Research Journals	Bx
<i>Nature Neuroscience</i>	Nature Research Journals	Sh
<i>Nature Photonics</i>	Nature Research Journals	Bx
<i>Nature Physics</i>	Nature Research Journals	Bx
<i>Nature Reviews Cancer</i>	Reviews (Life Science)	PF
<i>Nature Reviews Cardiology</i>	Reviews (Clinical)	PF
<i>Nature Reviews Clinical Oncology</i>	Reviews (Clinical)	PF
<i>Nature Reviews Drug Discovery</i>	Reviews (Life Science)	Bx
<i>Nature Reviews Endocrinology</i>	Reviews (Clinical)	PF
<i>Nature Reviews Gastroenterology & Hepatology</i>	Reviews (Clinical)	PF
<i>Nature Reviews Genetics</i>	Reviews (Life Science)	PF
<i>Nature Reviews Immunology</i>	Reviews (Life Science)	PF
<i>Nature Reviews Microbiology</i>	Reviews (Life Science)	PF
<i>Nature Reviews Molecular Cell Biology</i>	Reviews (Life Science)	PF
<i>Nature Reviews Nephrology</i>	Reviews (Clinical)	PF
<i>Nature Reviews Neurology</i>	Reviews (Clinical)	PF
<i>Nature Reviews Neuroscience</i>	Reviews (Life Science)	PF
<i>Nature Reviews Rheumatology</i>	Reviews (Clinical)	PF
<i>Nature Reviews Urology</i>	Reviews (Clinical)	PF
<i>Nature Structural & Molecular Biology</i>	Nature Research Journals	Sh
<i>Neuropsychopharmacology</i>	Academic Journals	Sh
<i>Oncogene</i>	Academic Journals	PF
<i>Pediatric Research</i>	Academic Journals	Sh
<i>Prostate Cancer and Prostatic Diseases</i>	Academic Journals	Sh
<i>Spinal Cord</i>	Academic Journals	PF
<i>The ISME Journal</i>	Academic Journals	PF
<i>The Pharmacogenomics Journal</i>	Academic Journals	Sh